

RoHS GP HF

REV.	ECN MARK	ECN NO.	DESCRIPTION	DRAWN	DATE
A	⊗	/	NEW	ZHUCHAO	2022/07/14

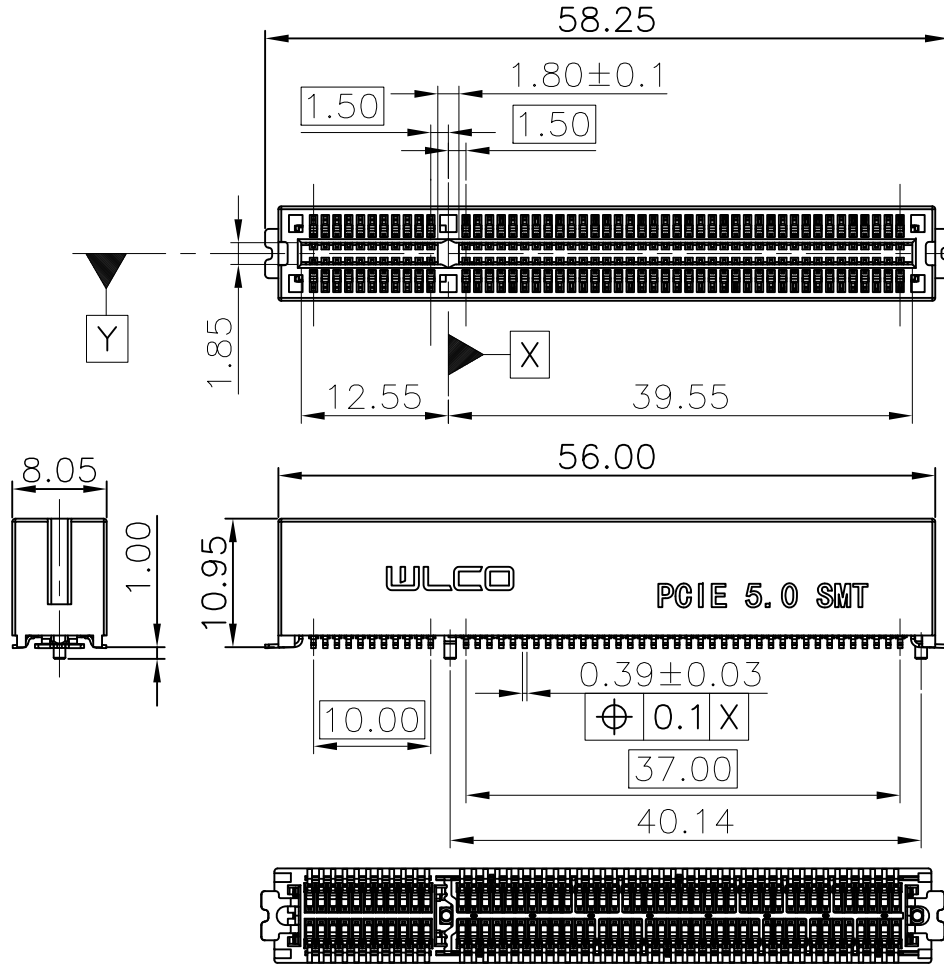

- ELECTRICAL PERFORMANCE
  - CURRENT RATING:1.1A PER PIN MAX;
  - LLCR:30mΩ MAX (INITIAL);
  - INSULATION RESISTANCE:500V DC,1000MΩ MIN;
  - DIELECRIC WITHSTAND VOLTAGE:500V AC,0.5mA MAX;
- MECHANICAL PERFORMANCE
  - INSERTION FORCE-MODULE TO CONNECTOR:1.15N MAX PER PAIR;
  - DURABILITY:50 CYCLES;
  - UNMATING FORCE(PER PIN PAIR):0.15N MIN;
- RECOMMENDED CONDITION FOR SMT SOLDERING:
  - PEAK TEMPERATURE SHALL BE 260+/-5°C
  - DURATION 10±2 SECONDS.
- HF COMPLIANT

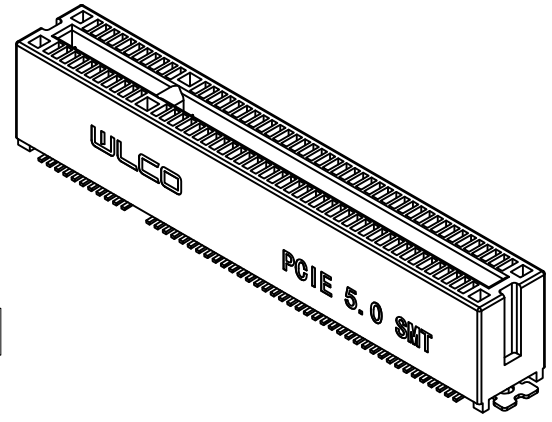

4	GROUND	1	STAINLESS	
3	HOOK	2	MEDIUM CARBON STEEL	
2	CONTACT	98	COPPER ALLOY	
1	HOUSING	1	HIGH TEMPERATURE THERMOPLASTIC	
ITEM	NAME	Q'TY	SPEC DESCRIPTION	REMARKS
TOLERANCE		MODEL NAME:	PCIE 98PIN,GEN5 SMT	DRAWN: ZHUCHAO
X.X	±0.35	MODEL NO:	SEE TABLE	CHECKED: YOUHUA.CAI
X.XX	±0.25	UNIT:	SCALE: REVISION: SHEET:	APPROVED: YOUHUA.CAI
X.XXX	±0.10	mm	8:5 A 1/2	DATE: 2022/07/14
ANGLE	±2.0°	<b>WLCO</b> 深圳市兴万联电子有限公司 SHENZHEN XING WAN LIAN ELECTRONICS CO.,LTD.		DWG NO: C-WLPC-98P08
				FILE: C

RoHS GP HF

REV.	ECN MARK	ECN NO.	DESCRIPTION	DRAWN	DATE
A	⊗	/	NEW	ZHUCHAO	2022/07/14

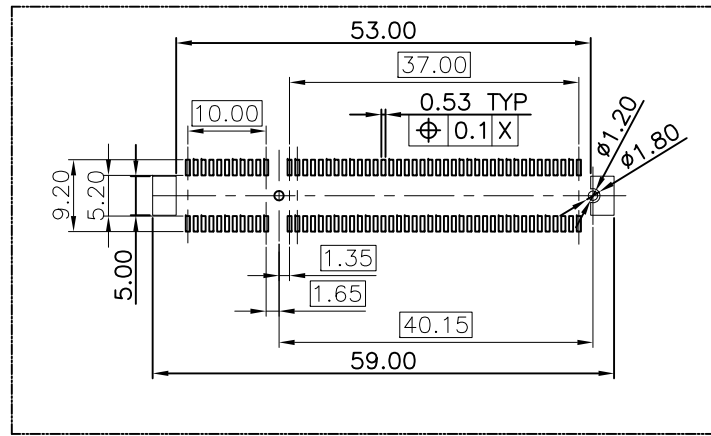

RECOMMENDED PCB LAYOUT  
DEFAULT TOLERANCE ±0.05

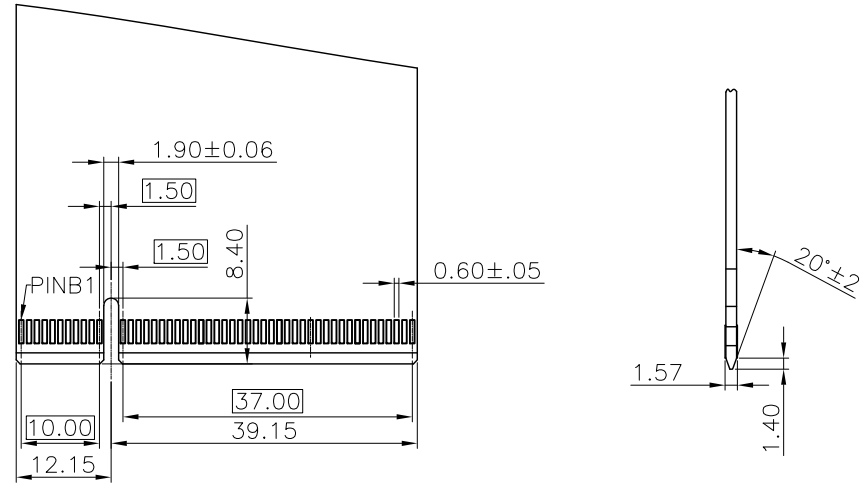

PRIMARY (COMPONENT) SIDE

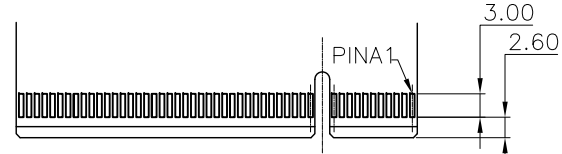

SECONDARY (SOLDER) SIDE

RECOMMENDED CARD EDGE FINGER

DEFAULT TOLERANCE ±0.05

NOTES:

- NO TIE PERMITTED FROM CARD EDGE TO LEADING EDGE OF PAD FOR PINS A1 AND 'C'.
- CHAMFER EDGES MUST BE FREE OF CUTTING BURRS.

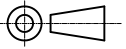
TOLERANCE X.X ±0.35 X.XX ±0.25 X.XXX ±0.10 ANGLE ±2.0°	MODEL NAME:	PCIE 98PIN,GEN5 SMT			DRAWN:	ZHUCHAO
	MODEL NO.:	SEE TABLE			CHECKED:	YOUHUA.CAI
	UNIT:	SCALE:	REVISION:	SHEET:	APPROVED:	YOUHUA.CAI
	mm	1:1	A	2/2	DATE:	2022/07/14
 <b>WLCO</b> 深圳市兴万联电子有限公司 SHENZHEN XING WAN LIAN ELECTRONICS CO.,LTD.	DWG NO.:	C-WLPC-98P08			FILE:	C

1 2  
**RoHS** **GP** **HF**

REV.	ECN MARK	ECN NO.	DESCRIPTION	DRAWN	DATE
A	⊗	/	NEW	ZHUCHAO	2022/07/14

**TABLE**

NO.	PART NO.	SPECIFICATION	HSF COMPLIANT
1	WLPC-145A	HOUSING_PA10T BLACK UL94-V0,CONTACT_C5191 Au15u" Sn100u",HOOK_S50C Sn100u",GROUND SUS301.	HF COMPLIANT

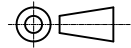
TOLERANCE X.X ±0.35 X.XX ±0.25 X.XXX ±0.10 ANGLE ±2.0°	MODEL NAME:	PCIE 98PIN,GEN5 SMT			DRAWN:	ZHUCHAO
	MODEL NO:	SEE TABLE			CHECKED:	YOUHUA.CAI
	UNIT:	SCALE:	REVISION:	SHEET:	APPROVED:	YOUHUA.CAI
	mm	1:1	A	1/1	DATE:	2022/07/14
 <b>WLCO</b> 深圳市兴万联电子有限公司 SHENZHEN XING WAN LIAN ELECTRONICS CO.,LTD.				DWG NO:	C-WLPC-145A	
				FILE:	C	